



**PURSUIT**  
Alu-Tech Bodyshell

**PEGASUS**  
Alu-Tech Bodyshell  
**GT65**

**UNICORN**  
Alu-Tech Bodyshell 



## Welcome to Bailey of Bristol

### Welcome to the Bailey of Bristol touring caravan range.

Bailey caravans have been developed using over sixty-five years of experience in caravan design and are manufactured in our state-of-the-art South Liberty Lane production facility to provide, what we believe to be, the very best in touring home quality and value.

All of our products are built using our patented Alu-Tech construction system and incorporate the core Bailey values of award winning design, first class build quality and unbeatable value for money. Plus to ensure that they remain some

of the best-engineered and most technically advanced caravans available, we subject them to a programme of continuous testing through leading independent experts which takes them as far afield as the Australian Outback and the European Alps.

As a result, we are proud to present three distinct caravan ranges which offer something to suit every lifestyle and budget. To help make an informed decision about which of our models will best meet your needs, we recommend you visit your local retailer who will be happy to demonstrate why Bailey is the UK's favourite touring caravan brand.



Keeping in touch:



[www.baileyofbristol.co.uk](http://www.baileyofbristol.co.uk)

# PURSUIT

Alu-Tech Bodyshell

*The pursuit of enjoyment*



06 Floorplans

11 Key Features

24 Product Specification



# PEGASUS

Alu-Tech Bodyshell

## GT65

*Take a closer look*



12 Floorplans

17 Key Features

25 Product Specification

# UNICORN



Alu-Tech Bodyshell

*The complete picture*



18 Floorplans

23 Key Features

26 Product Specification

## Contents

Welcome to Bailey of Bristol	02
Alu-Tech Bodyshell Construction	04-05
Pursuit	06-11
Pegasus GT65	12-17
Unicorn	18-23
Product Specifications	24-26
Why Choose Bailey	27
Technical Specifications	28-30
Towing Stability	31

## About Alu-Tech

Prior to the introduction of the Alu-Tech construction system in 2009 there had been little change in leisure vehicle bodyshell design for over thirty years. Whilst conventional construction served us well during that period with the advances in production technology and materials we asked: was there a better way?

Two years in the making and the result was the development of our patented Alu-Tech design technology which takes a completely new approach to bodyshell construction. Using a unique interlocking aluminium external framework to which the body panels are bonded and then clamped using internal fixings it has a much stronger and more rigid shell which provides greater protection against the elements.

The sole use of thicker fully laminated panels in this new assembly greatly enhances the thermal performance of the shell, making our caravans genuine four-season vehicles. The replacement of the timber elements in the sides and roof with a composite plastic internal skeleton and GRP wall linings, in conjunction with a significant reduction in the number of external joints and fixing points, enhances its resistance to moisture ingress.

When you consider that these benefits of ownership were achieved without a cost or a weight penalty you can begin to see why the Alu-Tech construction system is so unique.

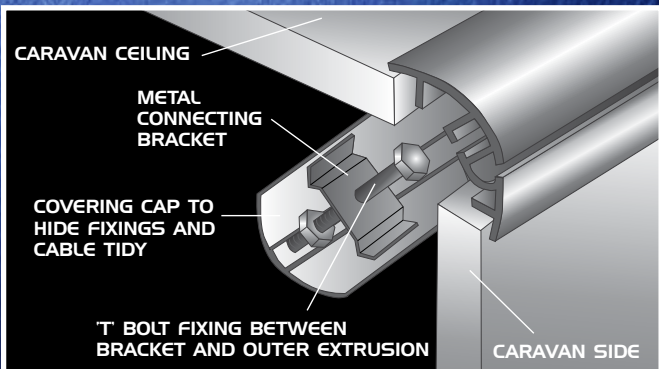

FEATURES OF ALU-TECH	BENEFITS TO YOU
Sole use of thicker fully laminated bodyshell panels covered in an impact resistant outer GRP skin	Increased strength and durability providing greater protection against the elements Enhanced thermal insulation capabilities to enable holidaying all year round
Interlocking aluminium extrusion external framework with internal fixings	Increased strength and durability providing greater protection against the elements Minimises the number of potential water access points to improve the overall integrity of the shell
Timber free upper bodyshell panels featuring a composite plastic internal skeleton and a GRP inner wall lining	Improved durability by limiting the impact any possible ingress water may cause
Lighter bodyshell with a more balanced weight distribution	Lighter caravans accessible to owners of a wider range of tow vehicles Increased stability and improved road handling for safer towing
Cost neutral design technology	Advanced technology universally available at no extra cost

## CLIMATE CHAMBER TESTING

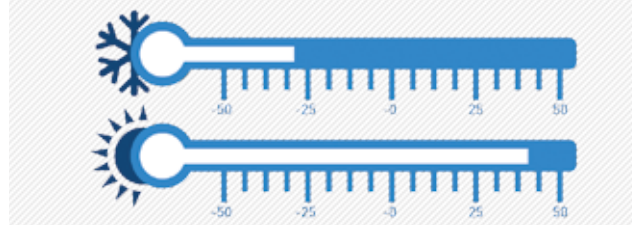

Tested in extreme temperatures, as low as -28°C and as high as 40°C in a climate control chamber



Terms and conditions apply. All of our caravans are supplied with a 6 year transferable bodyshell integrity and a 3 year transferable manufacturers components warranty. 4 year transferable extension to bodyshell integrity guarantee available as a cost option (making 10 years in total). Please visit [www.baileyofbristol.co.uk](http://www.baileyofbristol.co.uk) for more information on the warranty package.



### Design Innovation

The Alu-Tech construction system is 10% lighter compared to conventional construction



For the full Alu-Tech story visit [www.baileyofoxford.co.uk](http://www.baileyofoxford.co.uk)

### Design Innovation

Timber-free and GRP clad upper bodysell panels give greater protection against the elements



### Extreme Testing

Equivalent to 40 years accelerated life testing carried out at Millbrook on numerous road surfaces



# PURSUIT

Alu-Tech Bodyshell



*The pursuit of enjoyment*



## What makes Pursuit different?

- A low-cost light-weight first caravan range in a choice of six best-selling layouts suitable for couples and large families
- Balanced 14" alloy wheels fitted with anti-tamper WSL Safety Bolts and a high security entrance door lock for additional peace of mind
- A stylish and distinctive exterior with a well-equipped interior to accommodate your everyday needs
- A fully specified Truma Combi heating system with digital control panel for complete comfort all year round
- The option to upgrade the specification with a Premium Pack and sunroof allowing you to tailor the caravan to specifically suit your requirements

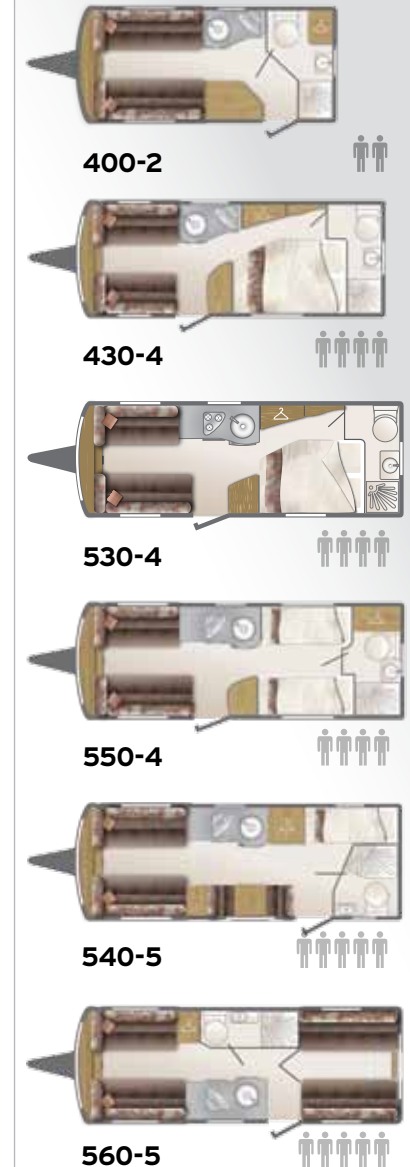

The well-designed, well-equipped yet affordable Pursuit range stands out from the crowd with its stylish and distinctive slate grey and polar white exterior with contemporary graphics and 14" alloy wheels. Offering the lightest weights in the Bailey portfolio, Pursuit can be towed by a wide range of tow vehicles.

High quality fixtures and fittings, practical kitchens and spacious washrooms make the Pursuit a perfect base to enjoy outdoor activities in all weathers, as well as the ideal place to refresh and relax afterwards.

**Opposite:** Pursuit 430-4 (Optional Premium Pack and opening sunroof fitted)









**Anti-clockwise from top left:** Pursuit 540-5 kitchen (Optional Premium Pack fitted); Pursuit 550-4 twin fixed single beds (Optional bed linen shown); Pursuit 560-5 washroom.

**Right:** Standard Spice soft furnishings.



Step inside the Pursuit to experience the contemporary design and light and airy interiors. Italian design overhead locker doors with chrome handles, premium quality fabrics and De-Luxe sprung mattresses for fixed-bed models add to the high quality look and feel.

Pursuit boasts an impressive range of home comforts including a Truma Combi boiler with a user-friendly digital control panel, up to five 230v power sockets for all of today's essential electrical equipment, Thetford Duplex combination oven and grill, Dometic 103 litre fridge and a large separate shower cubicle with a bi-fold door and an Ecocamel shower head that's not only more powerful but also uses less water.

*360° product tours for all layouts can be viewed at [www.baileyofbristol.co.uk](http://www.baileyofbristol.co.uk). To find a specific Pursuit model visit the 'Find your Vehicle' section on the same website.*



Key Pursuit features:



1) 14" Alloy wheels fitted with 'Security' tyres and anti-tamper WSL Safety Bolts. 2) Loose fit drop in carpets. 3) Status 550 telescopic directional digital television aerial. 4) Dual fuel Truma Combi boiler with digital control panel. 5) Ecocamel shower head. 6) High security entrance door lock.

Optional Extras:



1) Polyplastic double glazed opening sunroof with night blind in front dome. 2) AL-KO ATC Trailer Control System.

Optional Premium Pack:



Contents include: 1) AL-KO 3004 AKS Stabiliser. 2) Branded Radio/CD/MP3 player with iPod/MP3 player connection point. 3) Floor mounted steel spare wheel & retainer. 4) Exterior door flyscreen. 5) Stainless steel 800 watt microwave oven.

Alu-Tech Bodyshell

# PEGASUS

## GT65



Our 65th anniversary Pegasus GT65 mid-market range offers an enticing combination of style, sophistication and specification to provide owners with great value for money caravans at a weight suitable for a wide selection of tow vehicles.

Available in a wide choice of layouts these popular caravans are ideal for families and couples alike with the spacious interiors, featuring modern kitchens and well-equipped washrooms, capable of accommodating up to six people in complete comfort.

Take a closer look



### What makes Pegasus GT65 different?

- A mid-market range in a choice of six best selling layouts suitable for both couples and large families
- Superior safety package with the AL-KO ATC Trailer Control System, AL-KO AKS stabiliser, AL-KO shock absorbers and Michelin branded tyres with anti-tamper WSL Safety Bolts all supplied as standard
- A fully specified Whale blown air heating and rapid heat hot water system for complete comfort all year round
- Light and spacious interiors created with unique design features such as an opening vertical skylight and recessed front chest for greater levels of comfort

Genoa	2 people
Verona	3 people
Rimini	3 people
Ancona	4 people
Bologna <small>Twin-Axle</small>	3 people
Turin <small>Twin-Axle</small>	4 people

Opposite: Pegasus GT65 Verona







**Anti-clockwise from top left:** Pegasus GT65 Verona kitchen; Pegasus GT65 Rimini twin fixed single beds (Optional Amaro upholstery and bed linen shown); Pegasus GT65 Genoa washroom

**Left:** Standard Catria soft furnishings.

The front vertical skylight creates a bright and welcoming interior, whilst clever design features such as a recessed front chest with slide-out table, has helped make practical use of the available space. Great attention to detail has been paid throughout the caravan with well thought out lighting, service provision and storage choices.

Pegasus GT65 has been designed for the modern day caravanner with up to six interior power sockets, a branded Radio/CD/MP3 player with iPod/MP3 player connectivity and a fully-equipped kitchen incorporating a Thetford dual-fuel hob with electric hotplate and a stainless steel 800W microwave oven. Inside the practical washroom you will find a large fully lined shower cubicle featuring an Ecocamel showerhead, finished off with a domestic fitted furniture look and feel.

360° product tours for all layouts can be viewed at [www.baileyofbristol.co.uk](http://www.baileyofbristol.co.uk). To find a specific Pegasus GT65 model visit the 'Find your Vehicle' section on the same website.

**Opposite:** Pegasus GT65 Bologna (Optional Amaro upholstery shown)





Key Pegasus GT65 features:



1) Opening vertical skylight. 2) 14" Alloy wheels fitted with 'Michelin' tyres and anti-tamper WSL Safety Bolts. 3) AL-KO ATC Trailer Control System, AL-KO AKS stabiliser & shock absorbers for safer towing. 4) Branded Radio/CD/MP3 player with iPod connectivity (cable not included). 5) Thetford dual-fuel hob with electric hotplate and 3 gas burners. 6) Whale floor mounted 4kw space heater. 7) AL-KO Secure portable wheel lock and high security entrance door lock for reduced insurance premiums and peace of mind. 8) Up to six interior sockets. 9) Whale I-Van Intelligent Control touch screen panel. 10) Stainless steel 800 watt microwave. 11) Recessed 2-drawer front chest with slide out occasional table. 12) Ecocamel shower head.

**Opposite:** Pegasus GT65 Verona (Standard Catria upholstery and optional bed linen shown)



The complete picture



## What makes Unicorn different?

- A top-of-the-range line-up in a choice of eight best-selling layouts suitable for both couples and small families
- Superior safety and security package including the AL-KO ATC Trailer Control System, Michelin branded tyres with anti-tamper WSL safety bolts, AL-KO Secure wheel lock and a TRACKER Retrieve Stolen Vehicle Recovery System
- Re-designed interiors offer more internal floor space, larger kitchen worktops and longer seats for more practical living
- A fully specified Alde programmable central heating system for greater efficiency and improved fuel economy
- Top of the range specification for today's modern caravanner includes a 100 watt Truma solar panel, DAB Radio/CD/MP3 player with USB connectivity and a slim-line large capacity tower refrigerator (single axle models only)

	Seville	
	Madrid	
	Valencia	
	Vigo	
	Cadiz	
	Barcelona <small>Twin-Axle</small>	
	Cartagena <small>Twin-Axle</small>	
	Cordoba <small>Twin-Axle</small>	

Opposite: Unicorn Cadiz







**Anti-clockwise from top left:** Unicorn Barcelona kitchen; Unicorn Cadiz twin fixed single beds (Optional Trafalgar upholstery and bed linen shown); Unicorn Cadiz washroom.

**Right:** Standard Kensington soft furnishings



The stylish new interior featuring a modern 'Mendip Ash' furniture finish is beautifully showcased by the signature vertical front skylight by day and new LED task and mood lighting by night. Italian design locker doors with a dual gloss finish and soft close hinges combine with high quality soft-furnishings plus chrome fixtures and fittings to give models that unmistakable touch of class.

Unicorn's four-season touring credentials are further enhanced with an upgraded Alde central heating system featuring a new more economical boiler, a user friendly digital control panel and an additional washroom radiator whilst the new Truma 100 watt solar panel allows you the extra freedom to holiday where and when you want.

These well thought-out caravans include a host of new features designed to make your life easier. Ranging from the chef-friendly kitchens offering additional worktop space and increased storage, plus a new slim-line Dometic 133 litre tower refrigerator\* to the fully-equipped washrooms featuring a separate square shower cubicle complete with a domestic style door and integral lighting. Everything has been considered to make trips away in your new Bailey Unicorn as relaxing as possible.

*360° product tours for all layouts can be viewed at [www.baileyofbristol.co.uk](http://www.baileyofbristol.co.uk). To find a specific Unicorn model visit the 'Find your Vehicle' section on the same website.*

**Opposite:** Unicorn Seville (Optional Trafalgar upholstery shown)

\*single axle models only. Twin axle layouts feature the existing Dometic 190 litre fridge freezer



*Key Unicorn features:*



- 1) Opening vertical skylight. 2) 100 watt Truma solar panel. 3) AL-KO Secure portable wheel lock, TRACKER system and high security one key operation for reduced insurance premiums and peace of mind. 4) 14" Alloy wheels fitted with 'Michelin' tyres and anti-tamper WSL Safety Bolts. 5) Recessed 2-drawer front chest with slide out occasional table and soft close drawers. 6) Twin concealed storage pockets. 7) Up to seven interior 230v sockets. 8) Drop-down extension combines with the kitchen worktop providing an additional useable space of up to 10%\*. 9) ALDE radiator heating and water heating system with washroom panel radiator. 10) Dometic 133 litre tower refrigerator providing 30% extra storage capacity\* (single axles only). 11) Branded DAB Radio/CD/MP3 player with USB connection point. 12) Fully lined rectangular shower cubicle with 25% additional space\*. \*Size comparison with equivalent models in the previous Unicorn range.

**Opposite:** Unicorn Barcelona (Standard Kensington upholstery and optional bed linen shown)

### ALU-TECH BODYSHELL

Structural interlocking aluminium extrusion external framework with no external fixing points and concealed awning channels on both sides | Five part fully bonded exterior panel assembly system | Upper body panels manufactured using superior bead application laminating technology for a stronger more consistent bond | Upper body panels built using a timber free construction, incorporating a composite plastic internal skeleton, a high density polystyrene insulation and a GRP inner wall lining | NEW upper body panels cloaked in a single sheet impact resistant GRP outer skin for extra durability | Supplied with a 6-year transferable bodyshell integrity guarantee and a 3-year transferable manufacturers components warranty\* | 4-year transferable extension to bodyshell integrity guarantee available as a cost option (making 10 years in total)\* | EN-1645 Grade III classification for heating and thermal insulation (cold chamber tested) | European Whole Vehicle Type Approved & certified by the National Caravan Council to be European Standard compliant

### EXTERIOR FEATURES

NEW distinctive duo-tone bodyshell colourways, in slate grey and polar white | AL-KO galvanised steel chassis, braking system and running gear | NEW one piece integrated front and rear impact resistant bumpers | NEW design step up a-frame fairing | 14" TUV tested alloy wheels | Hartal two part exterior door with moulded interior liner and map pocket | LED awning light with integral water management system | Double glazed Polyplastic opening windows throughout | Midi and mini Heki roof lights located throughout the main habitation area | NEW centrally mounted easy-access gas locker for enhanced stability and reduced nose weight | Status 550 telescopic directional digital television aerial | Twin front storage compartments (model specific) | NEW co-ordinating contemporary graphics scheme

### INTERIOR FEATURES

#### Space

Internal headroom of 1.96m (6'5") throughout the length of the caravan | Body width of 2.23m (7'4")

#### Furniture & Soft Furnishings

Bailey "Walnut" furniture finish | NEW large front window shelf | NEW recessed front drawer & slide out occasional table (model specific) | NEW drop down front table (model specific) | NEW construction front bed boxes with beech sprung bed box tops and slide out double bed make up (model specific) | NEW slatted front bed make-up system on easy glide track (model specific) | Backrest and seat ventilation boards | Free standing table with dedicated storage | NEW aircraft style overhead locker system with split level storage, domestic style metal hinges and chrome handles | Structural locker dividers with greater load bearing capacity | NEW dual finish Italian design overhead locker doors | NEW premium quality fixtures and fittings in polished chrome finish | NEW high gloss kitchen and washroom worktop laminate | NEW drop down kitchen worktop extension (model specific) | NEW solid domestic style washroom door with domestic metal handle | Foam filled upholstery featuring premium quality fabrics, high density filling and superior cushion construction and De-luxe sprung mattresses (model specific) | NEW standard 'Spice' soft furnishings with co-ordinating lined curtains, arm rests or bolster cushions (model specific) and two standard size scatter cushions | NEW optional Amaro soft furnishings with co-ordinating curtains, arm rests or bolster cushions (model specific) and four standard size cushions | Wood effect floor vinyl | Loose fit drop in carpets

### SERVICES

#### Electrical System

NEW 230v power supply with up to 5 interior sockets | TV station with 230v, 12v and a minimum of one aerial socket | 12v internal lighting system | Centrally located electrical control panel | Domestic style consumer unit with dedicated access door | Switch mode battery charger with 20 amps output | RCD/MCB protection for mains electric system | 25 metre mains connecting lead

#### Water & Gas System

NEW Dual fuel Truma Combi boiler (2kw gas & 1.8kw electric) with user friendly digital control panel including adjustable fan speed and water boost functions | Propane/Butane 30mb gas regulator mounted in gas locker compartment | Whale premium pump (submersible) | Inboard pressurised hot and cold fresh water system with reinforced hosing | Inboard rigid pipe waste plumbing system | NEW stainless steel circular kitchen sink and mixer tap, washing up bowl, drainer and chopping board | Thetford C-260 cassette toilet with integrated header tank | NEW inboard shower unit with ceramic ball mixer tap, Ecocamel shower head & bi-fold partition door | NEW washroom hand basin and mixer tap

### KITCHEN EQUIPMENT

NEW Dometic 103 litre refrigerator with electronic ignition | Thetford Duplex combination oven and grill with electronic ignition and flame failure device | Thetford 3-burner gas hob incorporating flush fitting glass hinged lid and conveniently located controls

### GENERAL EQUIPMENT

Remis retractable flyscreen and sunblinds to principal windows | NEW Remis flyscreen and splash proof roller blind for kitchen and washroom windows

### SAFETY & SECURITY

NEW WSL Individually Laser Balanced wheels fitted with 'Security' tyres and anti-tamper WSL Safety Bolts | Optional AL-KO Secure portable wheel lock | NEW high security entrance door lock | CRIS identity number etched to windows and caravan chassis | Concealed security data chip within caravan construction | Smoke alarm | Carbon Monoxide alarm

### OPTIONAL EXTRAS

NEW Polyplastic double glazed opening sunroof with night blind in front dome | AL-KO ATC Trailer Control System

#### Optional Premium Pack Contents:

AL-KO AKS 3004 Stabiliser | Floor mounted steel spare wheel & retainer | Exterior door flyscreen | Stainless steel 800 watt microwave oven | Branded Radio/CD/MP3 player with iPod/MP3 player connection point





## ALU-TECH BODY SHELL

Structural interlocking aluminium extrusion external framework with no external fixing points and concealed awning channels on both sides | Five part fully bonded exterior panel assembly system | Upper body panels manufactured using superior bead application laminating technology for a stronger more consistent bond | Upper body panels built using a timber free construction, incorporating a composite plastic internal skeleton, a high density polystyrene insulation and a GRP inner wall lining | NEW upper body panels cloaked in a single sheet impact resistant GRP outer skin for extra durability | Supplied with a 6-year transferable bodyshell integrity guarantee and a 3-year transferable manufacturers components warranty\* | 4-year transferable extension to bodyshell integrity guarantee available as a cost option (making 10 years in total)\* | EN-1645 Grade III classification for heating and thermal insulation (cold chamber tested) | European Whole Vehicle Type Approved & certified by the National Caravan Council to be European Standard compliant

## EXTERIOR FEATURES

AL-KO galvanised steel chassis, braking system and running gear | NEW one piece integrated front and rear impact resistant bumpers | NEW design step up a-frame fairing | NEW style 14" TUV tested alloy wheels | Hartal two part large aperture exterior door with window, blind and waste bin | LED awning light with integral water management system | NEW double glazed Polyplastic opening vertical skylight in front dome | Double glazed Polyplastic opening windows throughout | Midi and Mini Heki rooflights located throughout main habitation area | NEW centrally mounted easy-access gas locker for enhanced stability and reduced nose weight | Exterior 230v socket & gas BBQ point | Status 550 telescopic directional digital television aerial | NEW external solar panel connection provision | NEW enlarged twin front storage compartments | NEW design graphics scheme

## INTERIOR FEATURES

### Space

Internal headroom of 1.96m (6'5") throughout the length of the caravan | Body width of 2.24m (7'4")

### Furniture & Soft Furnishings

Bailey "Walnut" furniture finish | Large front window shelf | NEW recessed 2-drawer front chest with slide out occasional table | NEW construction front bed boxes with beech sprung tops and drop down flaps with slide out double bed make up | NEW Bailey "Walnut" finish skylight mounting with integral task lighting | Backrest and seat ventilation boards | NEW lightweight free standing table with dedicated storage | NEW aircraft style overhead locker system with split level storage, domestic style metal hinges and chrome handles | Structural locker dividers with greater load bearing capacity | NEW Italian design overhead locker doors | Premium quality fixtures and fittings in brushed steel finish | NEW contrasting kitchen overhead locker system | NEW Bailey "Walnut" kitchen wall finish | NEW slate finish kitchen and washroom worktop laminate | NEW design fixed double beds with aluminium frames and gas strut assisted opening mechanism | NEW solid domestic style washroom door with metal handle | NEW high-gloss white washroom wall finish | NEW fitted washroom furniture with integral hand basin | Fully sprung upholstery (except split cushions used in bunk make-up) featuring premium quality fabrics, high density filling and superior cushion construction and a De-Luxe sprung mattress (model specific) | NEW standard Catria soft furnishings with co-ordinating curtains, arm rests and four standard size scatter cushions | NEW optional Amaro soft furnishings with co-ordinating curtains, arm rests and four standard size scatter cushions | Wood effect floor vinyl | Deep pile loose fit drop in carpets (45 oz pile weight)

## SERVICES

### Electrical System

NEW 230v power supply with up to six interior sockets | TV station with 230v, 12v and a minimum of two aerial sockets | 12v internal lighting system including LED down-lighters and directional spotlights | NEW user friendly Whale I-Van Intelligent Control touch screen panel | Domestic style consumer unit with dedicated access door | Switch mode battery charger with 20 amps output | RCD/MCB protection for mains electric system | 25 metre mains connecting lead

### Water & Gas System

NEW Whale floor mounted 4kw space heater and blown air heating system | NEW Whale rapid heat water heater | Propane/Butane 30mb gas regulator mounted in gas locker compartment | Whale premium pump (submersible) | Inboard pressurised hot and cold fresh water system with reinforced hosing | Inboard rigid pipe waste plumbing system | NEW stainless steel circular kitchen sink and mixer tap, washing up bowl, drainer and chopping board | Thetford C-260 swivel cassette toilet | NEW inboard shower unit with ceramic ball mixer tap and Ecocamel shower head | NEW fully lined shower cubicle with bi-fold partition door and integral storage pod (model specific) | NEW washroom hand basin and mixer tap

## KITCHEN EQUIPMENT

NEW Dometic 103 litre refrigerator with electronic ignition (single axles only) | Dometic 117 litre refrigerator with electronic ignition (twin axles only) | NEW Thetford Caprice combined oven, grill and hob with electronic ignition and flame failure device | NEW dual-fuel hob with electric hotplate and 3 gas burners | Stainless steel 800 watt microwave oven

## GENERAL EQUIPMENT

NEW Remis pleated flyscreen and blinds to principal windows | NEW Remis 2-part pleated sunblind to vertical skylight | NEW Remis flyscreen and splash proof roller blind for kitchen and washroom windows | Hartal pleated full length flyscreen to exterior door | NEW branded Radio/CD/MP3 player with iPod/MP3 player connection point | NEW branded dual cone stereo speakers for superior sound quality | NEW style caravan clock

## SAFETY & SECURITY

AL-KO ATC Trailer Control System | AL-KO AKS 3004 Stabiliser | AL-KO shock absorbers | WSL Individually Laser Balanced wheels fitted with 'Michelin' tyres and anti-tamper WSL Safety Bolts | NEW wind down floor mounted spare wheel carrier and spare wheel (steel spare wheel) | AL-KO Secure portable wheel lock (two for twin axle models) | NEW high security entrance door lock | CRiS identity number etched to windows and caravan chassis | Concealed security data chip within caravan construction | Smoke alarm | Carbon monoxide alarm



### ALU-TECH BODYSHELL

Structural interlocking aluminium extrusion framework with no external fixing points and concealed awning channels on both sides | Five part fully bonded exterior panel assembly system | Upper body panels manufactured using superior bead application laminating technology for a stronger more consistent bond | Upper body panels built using a timber free construction, incorporating a composite plastic internal skeleton, a high density polystyrene insulation and a GRP inner wall lining | Upper body panels cloaked in a single sheet impact resistant GRP outer skin for extra durability | Supplied with a 6-year transferable bodyshell integrity guarantee and a 3-year transferable manufacturers components warranty\* | 4-year transferable extension to bodyshell integrity guarantee available as a cost option (making 10 years in total)\*\* | EN1645 Grade III classification for heating and thermal insulation (cold chamber tested) | European Whole Vehicle Type Approved & certified by the National Caravan Council to be European Standard compliant

### EXTERIOR FEATURES

NEW 'Polar white' bodyshell | NEW aero-dynamic & aesthetically enhanced rear bodyshell profile | NEW AL-KO one-piece galvanised steel chassis, braking system and running gear | NEW flush-fit front impact resistant bumper with integral chrome grab handles | NEW flush-fit rear impact resistant bumper with integral chrome grab handles & LED light clusters | NEW design step up a-frame fairing | 14" TUV tested alloy wheels | Heavy duty rear corner steadies | NEW Hartal GRP skin two part large aperture exterior door with window, blind and waste bin | LED awning light with integral water management system | Double glazed Polyplastic opening vertical skylight in front dome | Double glazed Polyplastic opening windows throughout | Midi and mini Heki roof lights located throughout the main habitation area | Centrally mounted easy-access gas locker for enhanced stability and reduced nose weight | Exterior 230v socket and Truma gas BBQ point | NEW 230v power inlet for mains hook-up | Status 550 telescopic directional digital television aerial | NEW external satellite connection point | NEW centrally located easy access large exterior storage locker with moulded liner | NEW co-ordinating graphics scheme

### INTERIOR FEATURES

#### Space

Internal headroom of 1.96m (6'5") throughout the length of the caravan | Body width of 2.28m (7'6") | Internal floor space up to 15% larger\*\* | Front seats up to 10% longer\*\* | Kitchen worktop space up to 10% larger\*\*

#### Furniture & Soft Furnishings

NEW Bailey "Mendip Ash" furniture finish | Large front window shelf with heating vents | NEW recessed 2-drawer front chest with slide out occasional table and soft close drawers | NEW twin concealed storage pockets | NEW double skin bed box frames with beech sprung tops and drop down flaps | NEW slatted front bed make-up system on easy-glide track | NEW leatherette skylight surround with integral ambient and task lighting | NEW angled backrest and seat ventilation boards for enhanced heating efficiency | NEW lightweight freestanding table with dedicated storage | NEW vented aircraft style overhead locker system with split level storage and domestic soft close metal hinges | Structural locker dividers with greater load bearing capacity | NEW dual finish Italian design overhead locker doors | NEW dual-position slide-out TV bracket (model specific - accommodates a TV up to 18.5" in size) | NEW premium quality chrome finish fixtures and fittings | NEW internal grab handle for ease of access in and out of the caravan (model specific) | NEW leatherette multi-functional storage pouch | NEW "Italian stone" finish kitchen and washroom worktop laminate | NEW drop-down kitchen worktop extension | NEW co-ordinating Perspex splash-back | NEW design fixed double beds with aluminium frames and gas strut assisted opening mechanism | Solid domestic style washroom door with domestic metal handle | Fitted linen basket in washroom | Upholstery featuring premium quality fabrics, high density filling and superior 'Honeycore' foam construction | NEW Standard Kensington soft furnishings with co-ordinating curtains, four shaped arm rests, two large square and two small rectangular scatter cushions | NEW Optional Trafalgar soft furnishings with co-ordinating curtains, four

shaped arm rests, two large square and two small rectangular scatter cushions | NEW textured finish durable floor vinyl | NEW deep pile loose fit drop in carpets (55 oz pile weight)

### SERVICES

#### Electrical System

NEW Truma 100 watt solar panel | NEW 230v power supply with up to seven new design interior sockets | TV station with 230v, 12v and two aerial sockets | NEW 12v internal lighting system including LED down-lighters and directional spotlights | NEW 12v shower cubicle lighting | NEW centrally located under floor leisure battery storage locker | NEW centrally located electrical control panel | Domestic style consumer unit with dedicated access door | Switch mode battery charger with 20 amps output | RCD/MCB protection for mains electric system | 25 metre mains connecting lead

#### Water & Gas System

NEW Alde Hydronic Compact 3020 programmable radiator heating system with combined water heating | NEW Alde 3020 boiler for improved fuel economy | NEW Alde touch screen user-friendly control panel | NEW washroom panel radiator | Dual fuel 6.4 Kw gas and up to 3.15 Kw electric power sources | Propane/Butane 30mb gas regulator mounted in gas locker compartment | NEW On-board 40L water tank (twin axles only) | NEW Whale high flow submersible pump | Inboard rigid pipe waste plumbing system | Stainless steel circular kitchen sink with swan-neck mixer tap, washing up bowl, drainer and chopping board | Thetford C-260 cassette toilet with integrated header tank | Inboard shower unit with ceramic ball mixer tap and Ecomamel shower head | NEW large fully lined square shower cubicle with domestic style door and storage shelf | Extendable shaving mirror in washroom

### KITCHEN EQUIPMENT

NEW exclusive Dometic 133 litre tower refrigerator with electronic ignition (single axles only) | Dometic 190 litre fridge and freezer with electronic ignition (twin axles only) | Thetford Caprice combined oven, grill and hob with electronic ignition and flame failure device | Thetford dual-fuel hob with electric hotplate and 3 gas burners | Stainless steel 800 watt microwave oven

### GENERAL EQUIPMENT

Remis pleated flyscreen and blinds to principal windows | Remis 2-part pleated flyscreen and blind to vertical skylight | Hartal pleated full length flyscreen to exterior door | NEW branded DAB Radio/CD/MP3 player with iPod / MP3 player USB connection point | Branded dual cone stereo speakers for superior sound quality | Caravan clock

### SAFETY & SECURITY

AL-KO ATC Trailer Control System | AL-KO AKS 3004 Stabiliser | AL-KO shock absorbers | WSL Individually Laser Balanced wheels fitted with 'Michelin' tyres and anti-tamper WSL Safety Bolts | TyrePal Tyre Pressure Monitor System (TPMS) ready | Wind down floor mounted spare wheel carrier and spare wheel (steel spare wheel) | AL-KO caravan jack | AL-KO Secure portable wheel lock (two for twin axle models) | NEW TRACKER Retrieve with 5 year standby battery life (including first 3 months subscription fee) | NEW High security one key operation throughout | CRIS identity number etched to windows and caravan chassis | Concealed security data chip within caravan construction | Smoke alarm | Carbon monoxide alarm



\*Terms and conditions apply. Full specification and warranty information details can be found by visiting: [www.baileيوفbristol.co.uk](http://www.baileيوفbristol.co.uk)

\*\*Size comparison with equivalent models in the previous Unicorn range



1 in 3 caravans sold in the UK is a Bailey, making it the most popular brand



Bailey is the UK's longest established independent manufacturer with over 65 years experience in leisure vehicle production & design



Bailey leisure vehicles are designed to be 75% recyclable to make them more environmentally friendly

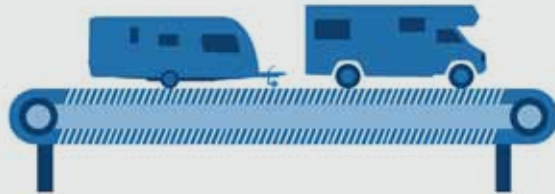

Bailey has the most advanced manufacturing plant in the UK, featuring the industry's only mechanised production line, allowing us to further improve both the quality and value of our vehicles



Bailey products have received more third party endorsements from leading industry sources than any other in recent years re-affirming our position as the UK's favourite leisure vehicle brand



All of our products are certified by the National Caravan Council and have attained Whole Vehicle Type Approval to ensure they are both legal and safe



Outback challenges totalling 26 days, 3000+ miles, +35°C



Alpine challenge totalling 7 days, 6 countries, 1,400 miles, -15°C

Our continuous programme of product development, using expertise from leading third-party authorities such as The University of Bath & the Millbrook Proving Ground, has taken real life testing of our caravans as far afield as the Australian Outback and the European Alps



Since 1948 approximately 165,000 Bailey leisure vehicles have been manufactured in Bristol. If positioned nose to tail these caravans and motorhomes would stretch over 1,000 miles - equivalent to the distance from Bristol to Vienna in Austria

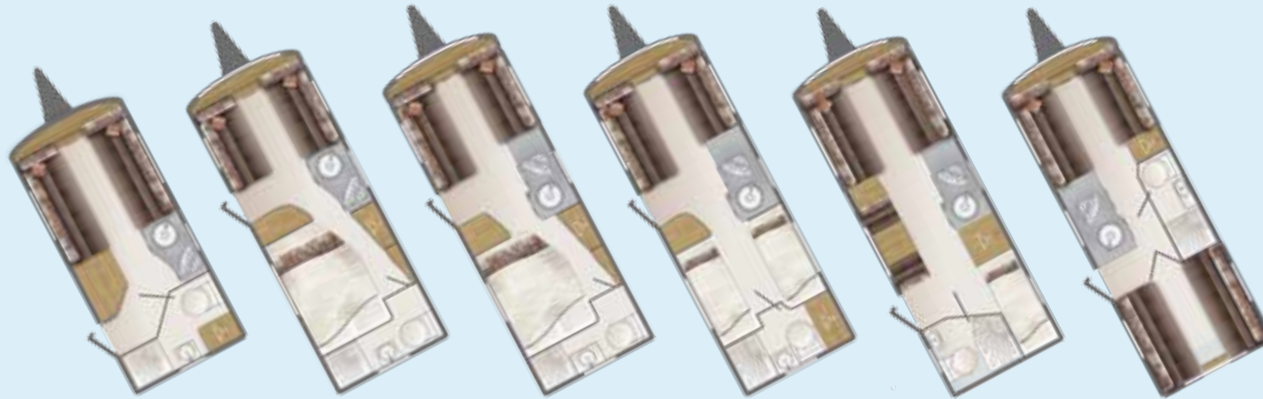

**400-2**

**430-4**

**530-4**

**550-4**

**540-5**

**560-5**

Berths	2	4	4	4	5	5
Internal Length	4.180m / 13'9"	5.226m / 17'2"	5.713m / 18'9"	5.713m / 18'9"	5.713m / 18'9"	5.713m / 18'9"
Shipping Length	5.410m / 17'9"	6.470m / 21'3"	7.380m / 24'3"	7.380m / 24'3"	7.380m / 24'3"	7.380m / 24'3"
Overall Width	2.230m / 7'4"	2.230m / 7'4"	2.230m / 7'4"	2.230m / 7'4"	2.230m / 7'4"	2.230m / 7'4"
Overall Height	2.61m / 8'7"	2.61m / 8'7"	2.61m / 8'7"	2.61m / 8'7"	2.61m / 8'7"	2.61m / 8'7"
Internal Headroom	1.96m / 6'5"	1.96m / 6'5"	1.96m / 6'5"	1.96m / 6'5"	1.96m / 6'5"	1.96m / 6'5"
Awning Size	843cm	955cm	1045cm	1045cm	1045cm	1045cm
Tyre Sizes	195/70 R14 LI96N	195/70 R14 LI96N	185 R14 LI104N	185 R14 LI104N	185 R14 LI104N	185 R14 LI104N
MTPLM	1090kg / 21.5cwt	1229kg / 24.2cwt	1377kg / 27.1cwt	1374kg / 27.0cwt	1394kg / 27.4cwt	1441kg / 28.4cwt
MRO	918kg / 18.1cwt	1036kg / 20.4cwt	1175kg / 23.1cwt	1172kg / 23.1cwt	1182kg / 23.3cwt	1229kg / 24.2cwt
Total User Payload	172kg / 3.4cwt	193kg / 3.8cwt	202kg / 4.0cwt	202kg / 4.0cwt	212kg / 4.2cwt	212kg / 4.2cwt
Front Double	5'6" x 6'8"	4'2" x 6'8"	4'10" x 6'8"	4'10" x 6'8"	5'3" x 6'8"	4'10" x 6'8"
Front N/S Single	6'2" x 2'5"	4'9" x 2'5"	5'10" x 2'6"	5'10" x 2'6"	5'8" x 2'6"	5'10" x 2'6"
Front O/S Single	6'1" x 2'5"	5'1" x 2'5"	5'2" x 2'6"	5'2" x 2'6"	5'8" x 2'6"	5'2" x 2'6"
N/S Single	-	-	-	-	5'7" x 2'4"	-
N/S Rear Single	-	-	-	-	-	5'7" x 2'6"
O/S Rear Single	-	-	-	-	-	5'11" x 2'6"
N/S Rear Fixed Single	-	-	-	6'8" x 2'4"	-	-
O/S Rear Fixed Single	-	-	-	6'4" x 2'4"	-	-
Rear Bunk	-	-	-	-	-	6'3" x 2'0"
Rear Fixed Bunks	-	-	-	-	6'0" x 2'1" (x2)	-
Rear Double	-	-	-	-	-	6'8" x 5'7"
Rear Fixed Double	-	6'3" x 4'6"	6'3" x 4'6"	-	-	-



Pursuit 540-5 (Standard Spice upholstery and optional bed linen shown)

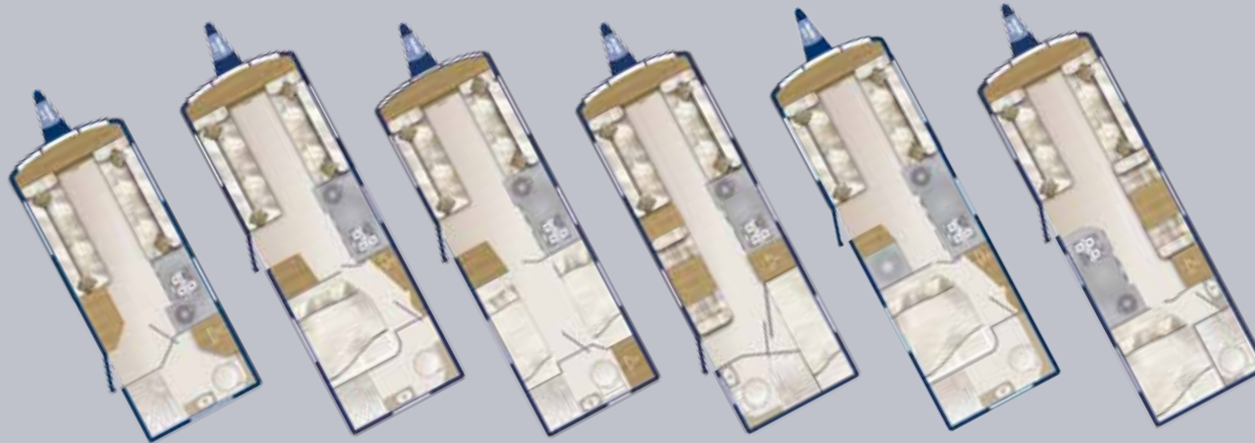

**Genoa**

**Verona**

**Rimini**

**Ancona**

**Bologna**  
Twin-Axle

**Turin**  
Twin-Axle

Berths	2	4	4	6	4	6
Internal Length	4.629m / 15'2"	5.682m / 18'8"	5.710m / 18'9"	5.682m / 18'8"	6.232m / 20'5"	6.232m / 20'5"
Shipping Length	6.293m / 20'8"	7.378m / 24'2"	7.400m / 24'3"	7.378m / 24'2"	7.935m / 26'0"	7.935m / 26'0"
Overall Width	2.230m / 7'4"	2.230m / 7'4"	2.230m / 7'4"	2.230m / 7'4"	2.230m / 7'4"	2.230m / 7'4"
Overall Height	2.61m / 8'7"	2.61m / 8'7"	2.61m / 8'7"	2.61m / 8'7"	2.61m / 8'7"	2.61m / 8'7"
Internal Headroom	1.96m / 6'5"	1.96m / 6'5"	1.96m / 6'5"	1.96m / 6'5"	1.96m / 6'5"	1.96m / 6'5"
Awning Size	940cm	1045cm	1048cm	1045cm	1093cm	1093cm
Tyre Sizes	185/R14 LI102R	185/R14 LI102R	185/R14 LI102R	185/R14 LI102R	185/65 R14 LI86T	185/65 R14 LI86T
MTPLM	1286kg / 25.3cwt	1448kg / 28.5cwt	1472kg / 29.0cwt	1496kg / 29.4cwt	1606kg / 31.6cwt	1676kg / 33.0cwt
MRO	1159kg / 22.8cwt	1290kg / 25.4cwt	1314kg / 25.9cwt	1318kg / 25.9cwt	1443kg / 28.4cwt	1493kg / 29.4cwt
Total User Payload	127kg / 2.5cwt	158kg / 3.1cwt	158kg / 3.1cwt	178kg / 3.5cwt	163kg / 3.2cwt	183kg / 3.6cwt
Front Double	5'9" x 6'8"	4'9" x 6'8"	4'9" x 6'8"	5'4" x 6'8"	5'4" x 6'8"	5'4" x 6'8"
Front N/S Single	6'5" x 2'5"	5'8" x 2'5"	5'8" x 2'5"	5'7" x 2'5"	5'8" x 2'5"	5'8" x 2'5"
Front O/S Single	6'1" x 2'5"	5'1" x 2'5"	5'1" x 2'5"	5'7" x 2'5"	6'1" x 2'5"	6'1" x 2'5"
N/S Single	-	-	-	5'7" x 2'1"	-	-
N/S Overhead Single	-	-	-	5'5" x 2'1"	-	-
O/S Single	-	-	-	-	-	5'7" x 2'3"
O/S Overhead Single	-	-	-	-	-	5'5" x 2'0"
Rear Fixed Bunks	-	-	-	6'0" x 2'0" (x2)	-	-
N/S Rear Fixed Single	-	-	6'0" x 2'3"	-	-	-
O/S Rear Fixed Single	-	-	6'3" x 2'3"	-	-	-
Rear Fixed Double	-	6'2" x 4'3"	-	-	6'2" x 4'3"	6'2" x 4'3"



A tolerance in the MRO has been allowed for in the calculations of Payload Margins. The awning length measurement shown is to be interpreted as a guide only and an enquiry should be made to individual awning manufacturers as to the correct size. Visit [www.baileyofbristol.co.uk](http://www.baileyofbristol.co.uk) for Pegasus GT65 metric bed sizes.

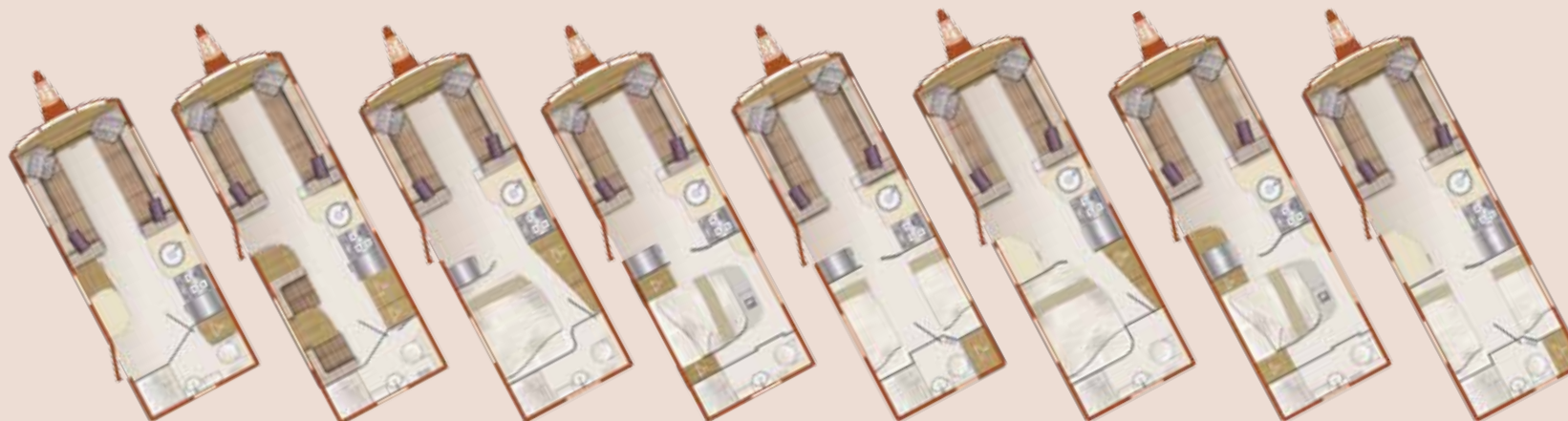

**Seville**

**Madrid**

**Valencia**

**Vigo**

**Cadiz**

**Barcelona**  
Twin-Axle

**Cartagena**  
Twin-Axle

**Cordoba**  
Twin-Axle

	2	3	4	4	4	4	4	4
Berths	2	3	4	4	4	4	4	4
Internal Length	4.915m / 16'2"	5.830m / 19'2"	5.830m / 19'2"	5.830m / 19'2"	5.830m / 19'2"	6.372m / 20'11"	6.380m / 20'11"	6.380m / 20'11"
Shipping Length	6.470m / 21'3"	7.372m / 24'2"	7.372m / 24'2"	7.372m / 24'2"	7.372m / 24'2"	7.920m / 26'0"	7.920m / 26'0"	7.920m / 26'0"
Overall Width	2.28m / 7'6"	2.28m / 7'6"	2.28m / 7'6"	2.28m / 7'6"	2.28m / 7'6"	2.28m / 7'6"	2.28m / 7'6"	2.28m / 7'6"
Overall Height	2.610m / 8'7"	2.610m / 8'7"	2.610m / 8'7"	2.610m / 8'7"	2.610m / 8'7"	2.610m / 8'7"	2.610m / 8'7"	2.610m / 8'7"
Internal Headroom	1.96m / 6'5"	1.96m / 6'5"	1.96m / 6'5"	1.96m / 6'5"	1.96m / 6'5"	1.96m / 6'5"	1.96m / 6'5"	1.96m / 6'5"
Awning Size	950cm	1045cm	1045cm	1045cm	1045cm	1091cm	1091cm	1091cm
Tyre Sizes	185/R14 LH102R	185/R14 LH102R	185/R14 LH102R	185/R14 LH102R	185/R14 LH102R	185/65 R14 LI86T	185/65 R14 LI86T	185/65 R14 LI86T
MTPLM	1369kg / 26.9cwt	1496kg / 29.4cwt	1493kg / 29.4cwt	1500kg / 29.5cwt	1491kg / 29.3cwt	1723kg / 33.9cwt	1717kg / 33.8cwt	1750kg / 34.4cwt
MRO	1242kg / 24.4cwt	1352kg / 26.6cwt	1339kg / 26.4cwt	1346kg / 26.5cwt	1337kg / 26.3cwt	1560kg / 30.7cwt	1554kg / 30.6cwt	1590kg / 31.3cwt
Total User Payload	127kg / 2.5cwt	144kg / 2.8cwt	154kg / 3.0cwt	154kg / 3.0cwt	154kg / 3.0cwt	163kg / 3.2cwt	163kg / 3.2cwt	160kg / 3.1cwt
Front Double	6'3" x 6'6"	6'2" x 6'6"	5'11" x 6'6"	5'0" x 6'6"	5'11" x 6'6"	5'9" x 6'6"	5'9" x 6'6"	5'10" x 6'6"
Front N/S Single	6'3" x 2'2"	6'2" x 2'2"	5'11" x 2'2"	5'3" x 2'2"	5'11" x 2'2"	5'9" x 2'2"	5'9" x 2'2"	6'0" x 2'2"
Front O/S Single	6'3" x 2'2"	6'4" x 2'2"	6'0" x 2'2"	5'0" x 2'2"	6'0" x 2'2"	6'0" x 2'2"	6'0" x 2'2"	5'10" x 2'2"
N/S Single	-	6'4" x 2'4"	-	-	-	-	-	-
N/S Rear Fixed Single	-	-	-	-	6'3" x 2'4"	-	-	6'3" x 2'4"
O/S Rear Fixed Single	-	-	-	-	5'10" x 2'4"	-	-	5'10" x 2'4"
Rear Fixed Double	-	-	6'2" x 4'5"	6'1" x 4'8"	-	6'2" x 4'5"	6'1" x 4'8"	-

A tolerance in the MRO has been allowed for in the calculations of Payload Margins. The awning length measurement shown is to be interpreted as a guide only and an enquiry should be made to individual awning manufacturers as to the correct size. Visit [www.baileyofbristol.co.uk](http://www.baileyofbristol.co.uk) for Unicorn metric bed sizes.

## Keeping you safe on the road

Bailey has worked closely with the Department of Mechanical Engineering at The University of Bath for many years to help develop the design and construction of our leisure vehicles with a view to optimising the towing performance of our caravans.

### Design

As a result of the research carried out we have made some key changes to the design and layout of our caravans to help make them inherently more stable with lower caravan nose weights, as a result making our caravans safer on the road. Changes include:

- The development of the Alu-Tech construction system which, with the absence of the heavy plastic cloaking panels found at the front and rear of conventionally built caravans, has a greater proportion of weight concentrated in the centre of the vehicle.
- Moving heavy items such as the gas bottle locker and battery box nearer to the centre of the caravan over the axle.

As a result of the lightweight Bailey design all of our single-axle caravans have an MTPLM of less than 1500kg further improving the towing stability of our caravans.

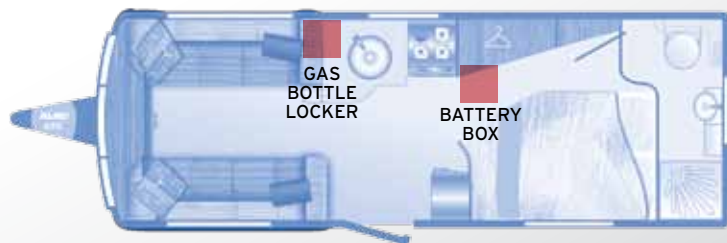

Above: The Unicorn Valencia floor plan shows the new location of the heavy items based on the research carried out.

### Safety

It is essential for your caravan to be matched with an appropriate towcar for safe towing. For further peace of mind the following items of safety equipment are fitted as standard or offered as a cost option on all our caravan ranges:



We have also worked with our wheel supplier, Wheel Solutions, to offer a unique package which sets our caravans apart from the rest. All of our caravan wheels are laser balanced ensuring even wear and tear on all of the tyres and every wheel is fitted with WSL Caravan Wheel Safety Bolts which have been designed to ensure the bolts stay tight\* and prevent wheel theft.



## Stability

It is important to load your caravan correctly as this can affect the towing performance of the caravan. Load heavy items such as the awning at a low level and as close to the axle as possible. Medium weight items such as food can be loaded around the heavy items whilst light items such as clothing and maps can be stored in the overhead lockers.



Above: The towing stability model developed by University of Bath shows how a trailer's stability varies according to the location of heavier items such as the gas bottle and battery.

\* Before hitching up the caravan always check the wheels bolt are tightened to the correct torque. \*\* Fitted to Pegasus GT65 and Unicorn ranges only.



[www.baileyofbristol.co.uk](http://www.baileyofbristol.co.uk)

South Liberty Lane, Bristol BS3 2SS, England

This brochure does not constitute an offer by Bailey Caravans Ltd (Bailey). Bailey reserves the right to alter specifications and prices as market and supply conditions demand. Your Bailey retailer will confirm all specification details prior to you making your purchasing decision. E. & O. E. Bailey retailers sell our products of their own choice and not as agents of Bailey. Accordingly they have no authority to bind Bailey or to make any representation or undertaking whatsoever on behalf of Bailey. All household items illustrated in this brochure are used to enhance photography and are for display purposes only. They are not supplied with your touring caravan. Photographic colour reproduction is subject to the limitations of the production process.

Design & Print: Kingsdown Photography: Alan Bond Issued: July 2014



MIX  
Paper from  
responsible sources  
FSC® C002239



NATIONAL CARAVAN  
COUNCIL LIMITED



*All Bailey models have been certified by the National Caravan Council for compliance with stringent European Standards, British Legislation and industry set Codes of Practice specifically relating to health and safety issues. NCC Approval gives you peace of mind that your caravan is safe and legal*